

LSM 510 META

Laser Scanning Microscope

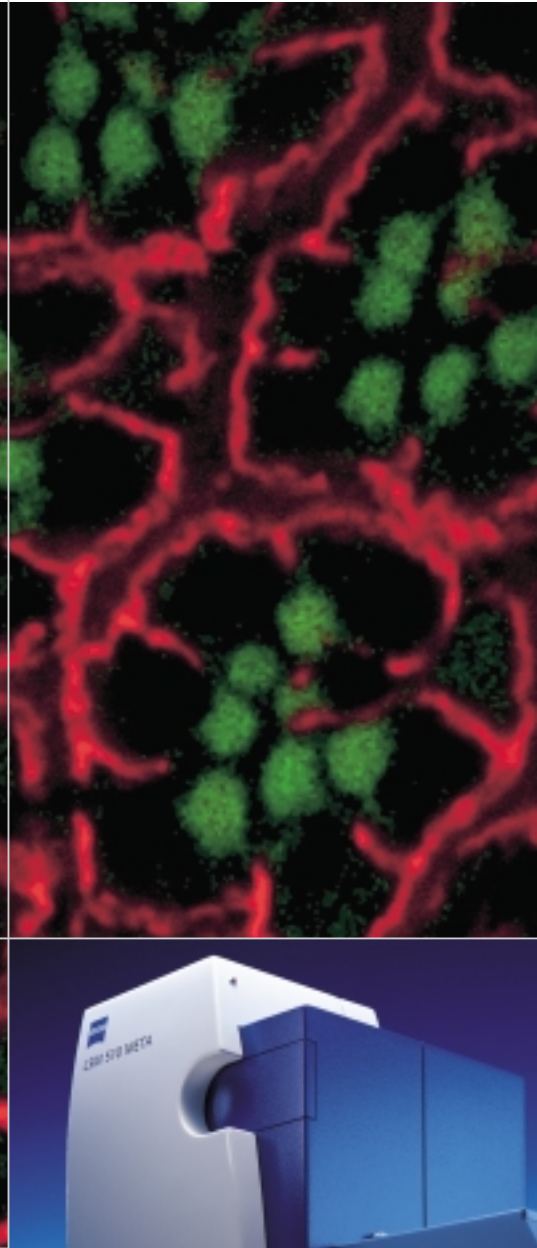

Fluorescence Signals Reliably Separated

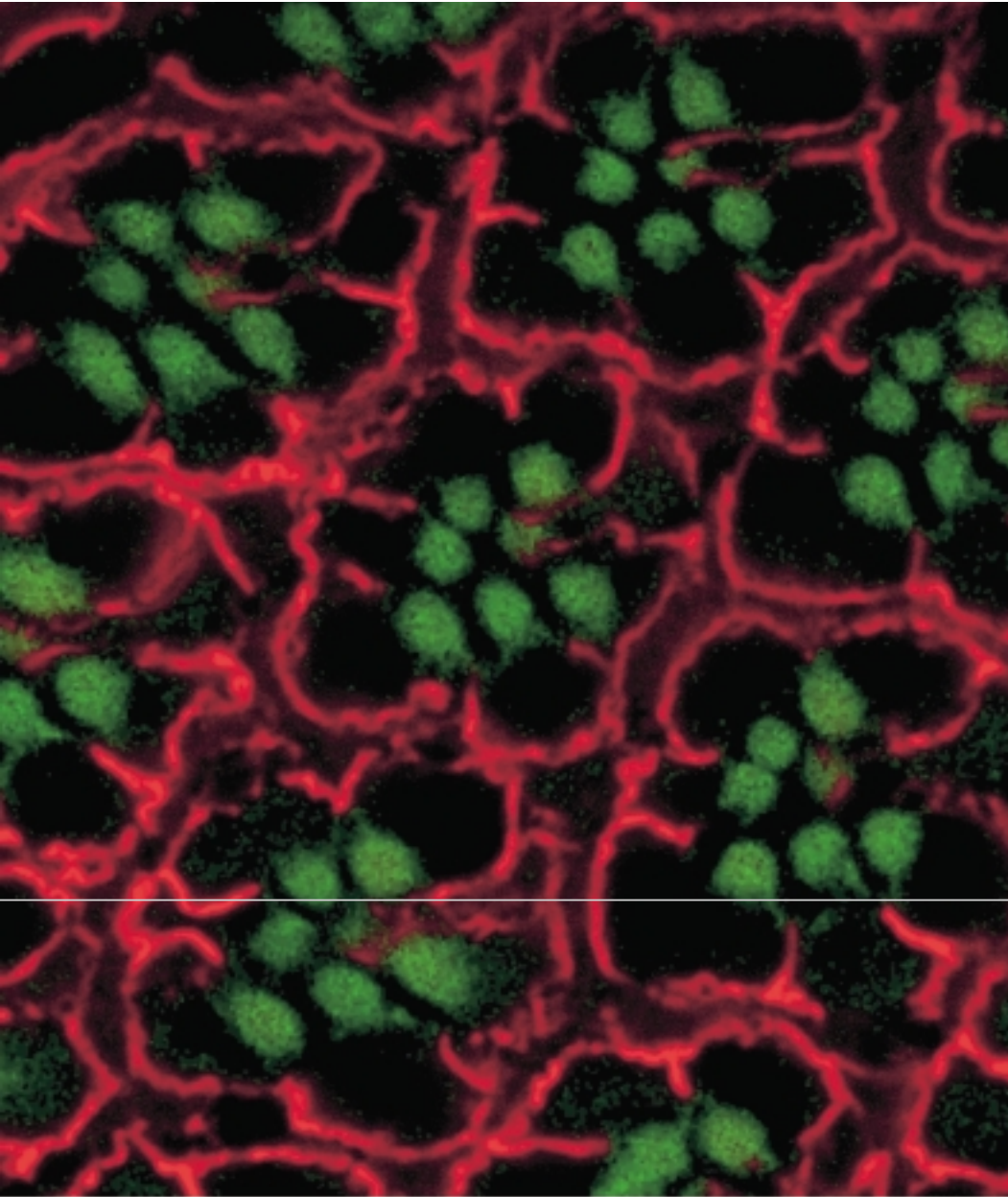

Highlights of Laser Scanning Microscopy

1 9 8 2

The first Laser Scanning Microscope from Carl Zeiss.
The prototype of the LSM 44 series is now on display in the
Deutsches Museum in Munich.



1 9 8 8

The LSM 10 – a confocal system
with two fluorescence channels.

1 9 9 1

The LSM 310 combines confocal laser
scanning microscopy with
state-of-the-art computer technology.



1 9 9 2

The LSM 410 is the first inverted micro-
scope of the LSM family.

1 9 9 7

The LSM 510 – the first system of the
LSM 5 family and a major breakthrough
in confocal imaging and analysis.



1 9 9 8

The LSM 510 NLO is ready for multi-
photon microscopy.

1 9 9 9

The LSM 5 PASCAL –
the personal confocal microscope.

2 0 0 0

The LSM is combined with
the ConfoCor 2 Fluorescence
Correlation Spectroscopy.

2 0 0 1

The LSM 510 META –
featuring multispectral analysis.

**LSM 510 META –
the difference between
“seeing a lot” and “detecting clearly”**

Conventional multifluorescence microscopy always reaches its limits when the emission signals of the dyes overlap. The LSM 510 META solves this problem. You will obtain brilliant images with an information content unachievable until now.

The Greek prefix “META” stands for “going beyond” the currently available.

The LSM 510 META is the new generation of laser scanning microscopes which leaves the old standard far behind – to allow you to see a lot, and to detect things clearly.

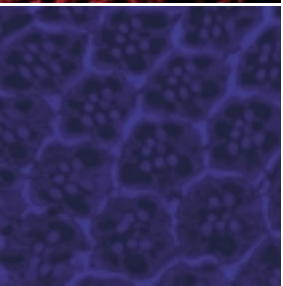
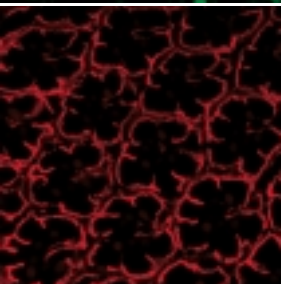
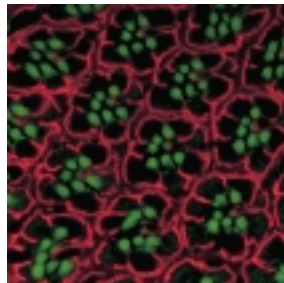
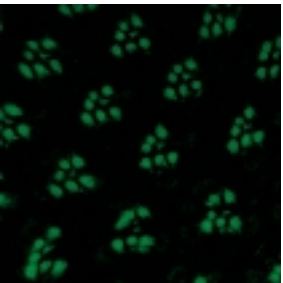

*Clear separation by Emission
Fingerprinting: Section through
the eye of the fruit fly
(Drosophila melanogaster).
Actin filaments marked
with Alexa Fluor 532 (green),
Na⁺/K⁺ ATPase with Cy3 (red),
autofluorescence (blue).
Specimen: Dr. Otto Baumann,
University of Potsdam, Germany*

Contents

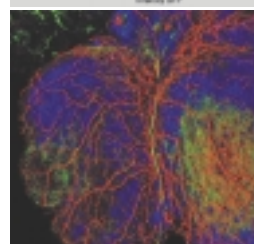
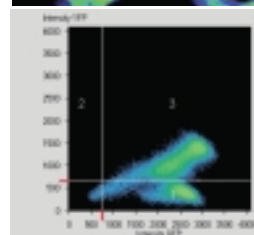
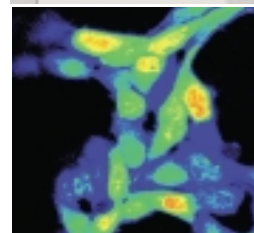
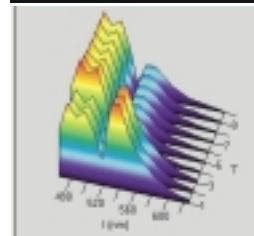
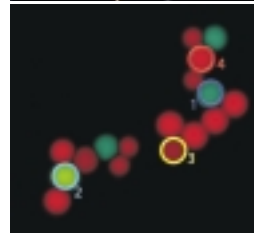
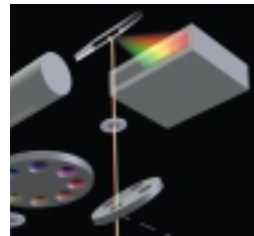

Confocal Principle	4
System Components	6
Emission Fingerprinting	8
Online Fingerprinting	10
Dynamic Spectral Analysis	11
Software	12
FRET and FRAP	16
Physiology Software	18
Quantitative Colocalization	19
Tools	20
Specification	22
System Overview	24
Services	26
Glossary	27



LSM 510 META



The Confocal Principle : Maximum Resolution and Efficiency

The advantage of confocal light microscopy is that it can collect the light reflected or emitted by a single plane of the specimen.

A pinhole conjugated to the focal plane obstructs the light coming from objects outside that plane, so that only light from in-focus objects can reach the detector. A laser beam scans the specimen pixel by pixel and line by line. The pixel data are then assembled into an image that is an optical section through the specimen, distinguished by high contrast and high resolution in x, y and z.

A number of images generated with the focal plane shifted in small steps can be combined into a 3-dimensional image stack which is available for digital processing.

*Beam path
in the confocal laser scanning microscope*

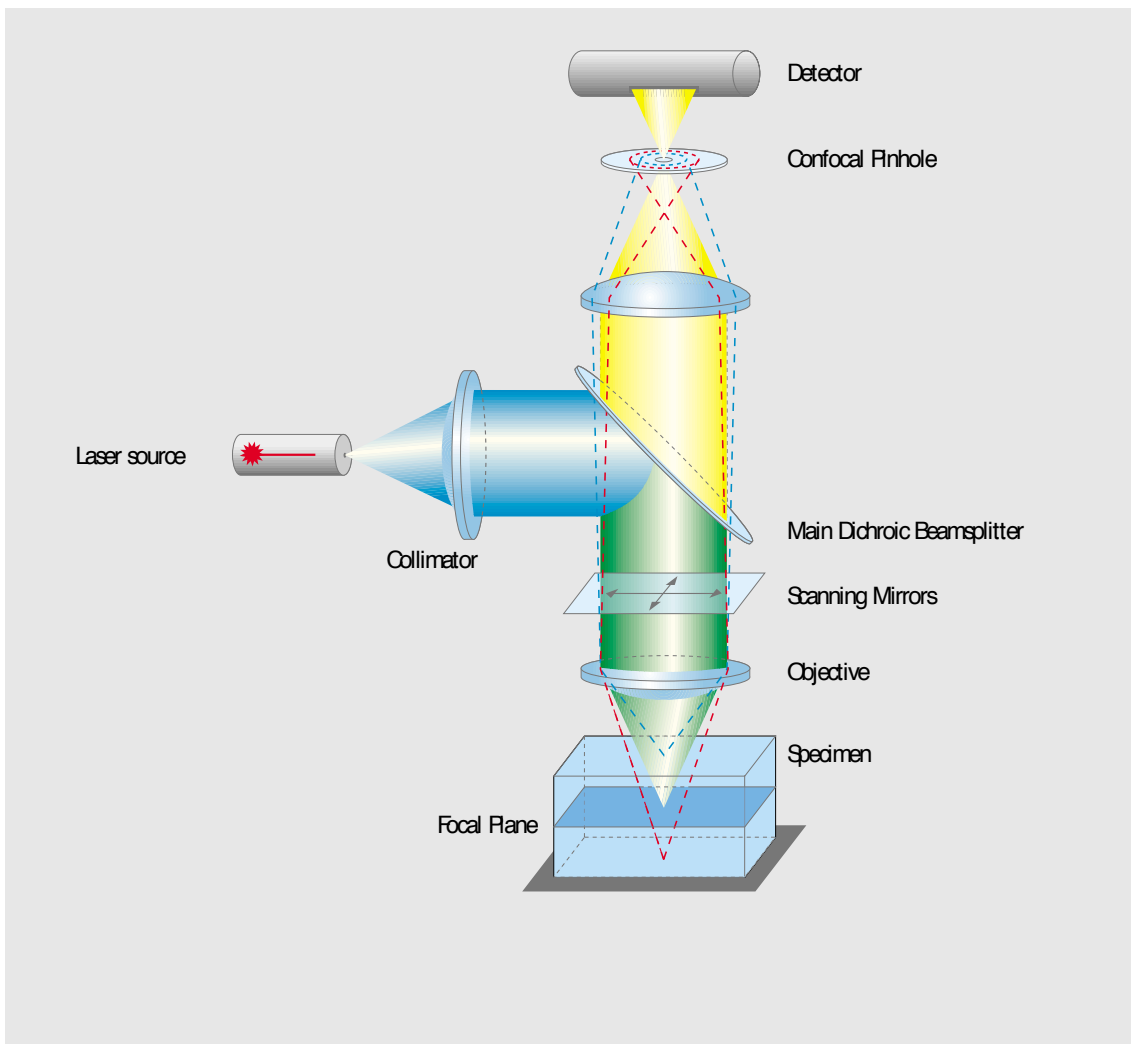

The Origin of Fluorescence

Under irradiation with light of a wavelength λ_{ex} , certain electrons of a fluorochrome are raised to a higher energy level. During a very short dwell time, they lose some of their energy and drop back to their original level while emitting light of a longer wavelength $\lambda_{em} > \lambda_{ex}$. The difference in wavelengths is known as the Stokes shift. In multiphoton excitation, the energies of several photons with n times the excitation wavelength add up to raise the electrons to the higher energy level.

The Properties of Fluorescence Spectra

A fluorescence molecule can be irradiated with different wavelengths within its excitation spectrum and, accordingly, will emit light with a characteristic emission spectrum. The amplitude of the emission spectrum is determined by the intensity of radiation and the excitation efficiency, which is a function of the excitation wavelength.

Separation of Emission Spectra

One way to separate fluorescence emissions is by high-quality dichroic beamsplitters with a threshold wavelength λ_{τ} . Thus, the beamsplitter reflects all wavelengths shorter, and transmits all wavelengths longer, than the threshold. The META detector with Emission Fingerprinting provides an alternative, much more flexible way of separating even strongly overlapping emission spectra.

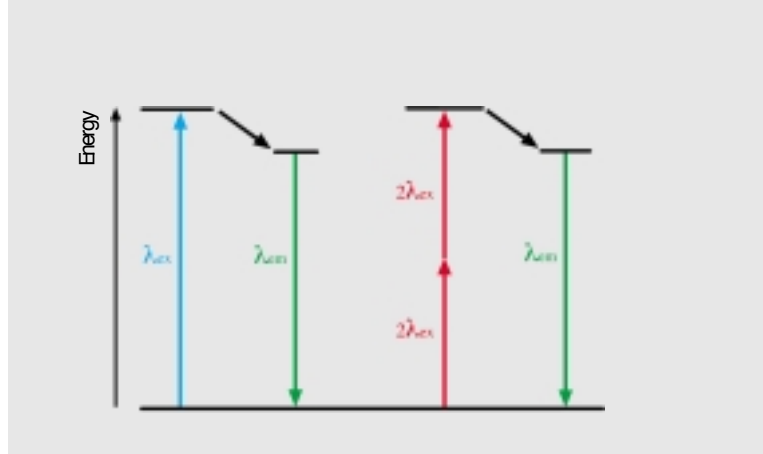

Energy diagram of fluorescence excitation, single photon excitation (left), multiphoton excitation (right).

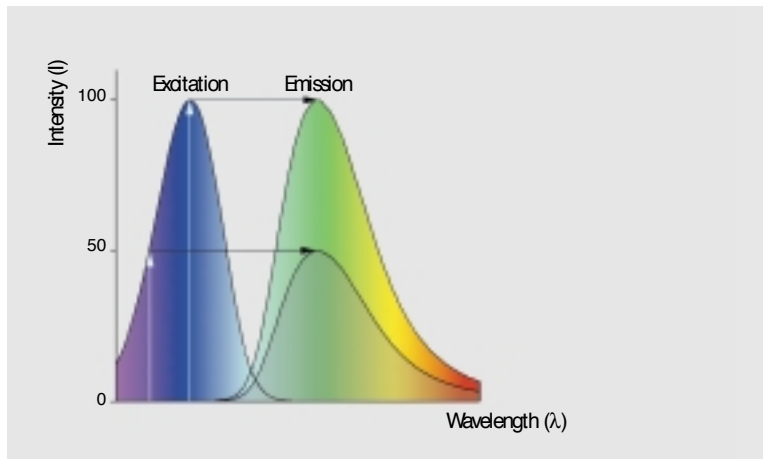

Excitation efficiency and emission intensity as a function of excitation wavelength.

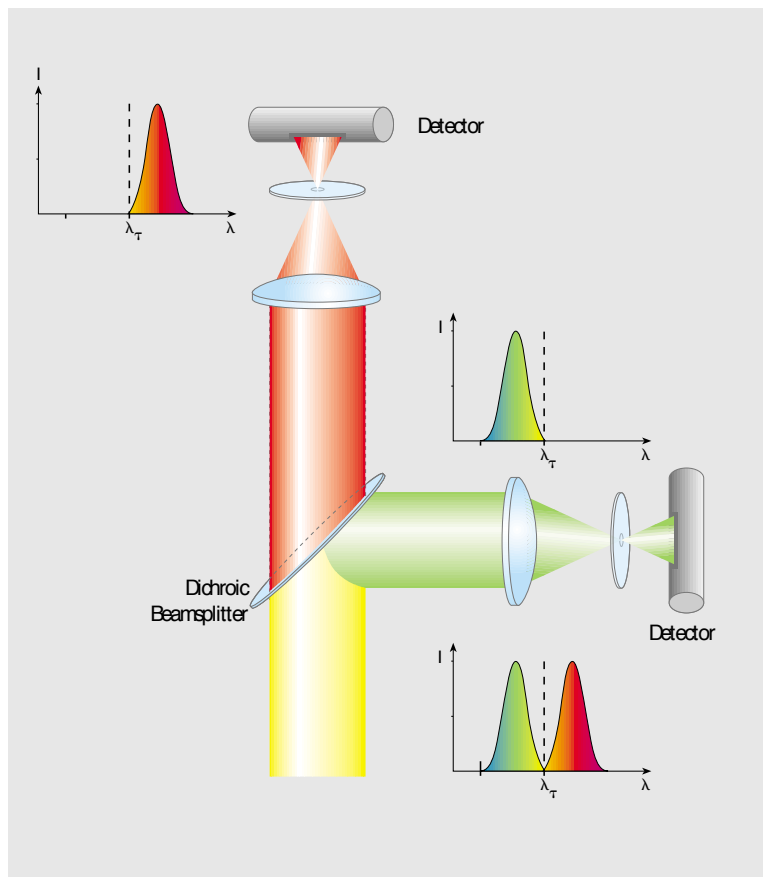

Separation of fluorescence emissions by means of dichroic filters.

System Components : A Perfect Match

In the way it implements the confocal principle, the design of the LSM 510 META system is unsurpassed. It allows multifuorescence images to be collected without compromising resolution and efficiency.

Microscopes

Every LSM 510 META is based on one of the high-performance research microscopes from Zeiss. Depending on your specific applications, you can choose between the following instruments:

Axioplan 2 imaging MOT, Axiovert 200M and Axioskop 2 FS MOT. All of them are equipped with ICS optics, which are unsurpassed for image quality, flexibility and optical perfection. The motorized microscope models are interchangeable and fully supported by the LSM software. The software automatically identifies the microscope settings and the objectives used, and controls all movements and measurements carried out by the system with high precision.

Objectives

Carl Zeiss objectives are highly regarded for their performance excellence. For the wide range of types and specifications, users can select those providing the optimum combination of resolving power, aperture, working distance and correction for their specific applications.

Laser Module

For excitation of fluorescent dyes and fluorescent proteins, the LSM 510 META is provided with different lasers emitting a number of lines in the UV and visible spectral ranges. The laser light is guided into the scanning module safely and efficiently via optical fibers. It is also possible to use direct or fiber-coupled tunable short-pulse lasers for multiphoton excitation. By means of an AOTF or an AOM, the excitation light is precisely controlled and can be blanked or unblanked down to one pixel. This provides the best possible specimen preservation and enables targeted photobleaching, e.g. for FRAP experiments.

Scanning Module

The unique scanning module is the core of the LSM 510 META. It contains motor-driven collimators, scanning mirrors, individually adjustable and positionable pinholes, and highly sensitive detectors including the META detector. All these components are arranged to ensure optimum specimen illumination and efficient collection of reflected or emitted light. A highly efficient optical grating provides an innovative way of separating the fluorescent emissions in the META detector. The grating projects the entire fluorescence spectrum onto the 32 channels of the META detector. Thus, the spectral signature is acquired for each pixel of the scanned image and can then be used for the digital separation into channels reflecting dye distributions.

Control Computer and Software

The LSM 510 META comes with an IBM-compatible PC equipped with a powerful processor. The easy-to-use LSM software enables you to control all system components. The Windows operating system provides multitasking capability and easy linking to existing computer networks. All components have been carefully selected and tested. The high-performance graphics card with OpenGL capability ensures fast presentation of 2D and 3D graphics and animations.

Electronics Module

The LSM 510 META is controlled by digital signal processors (DSP). This brings about fast, flexible synchronization of the scanners, the AOTF and the detectors, and enables such sophisticated functions as Multitracking, Spot Scan, fast Step Scan, rROI Scan, Spline Scan, or ROI Bleaching for FRAP, Uncaging and Photoactivation. Moreover, this technology permits the implementation of new scanning functions through simple software upgrades.

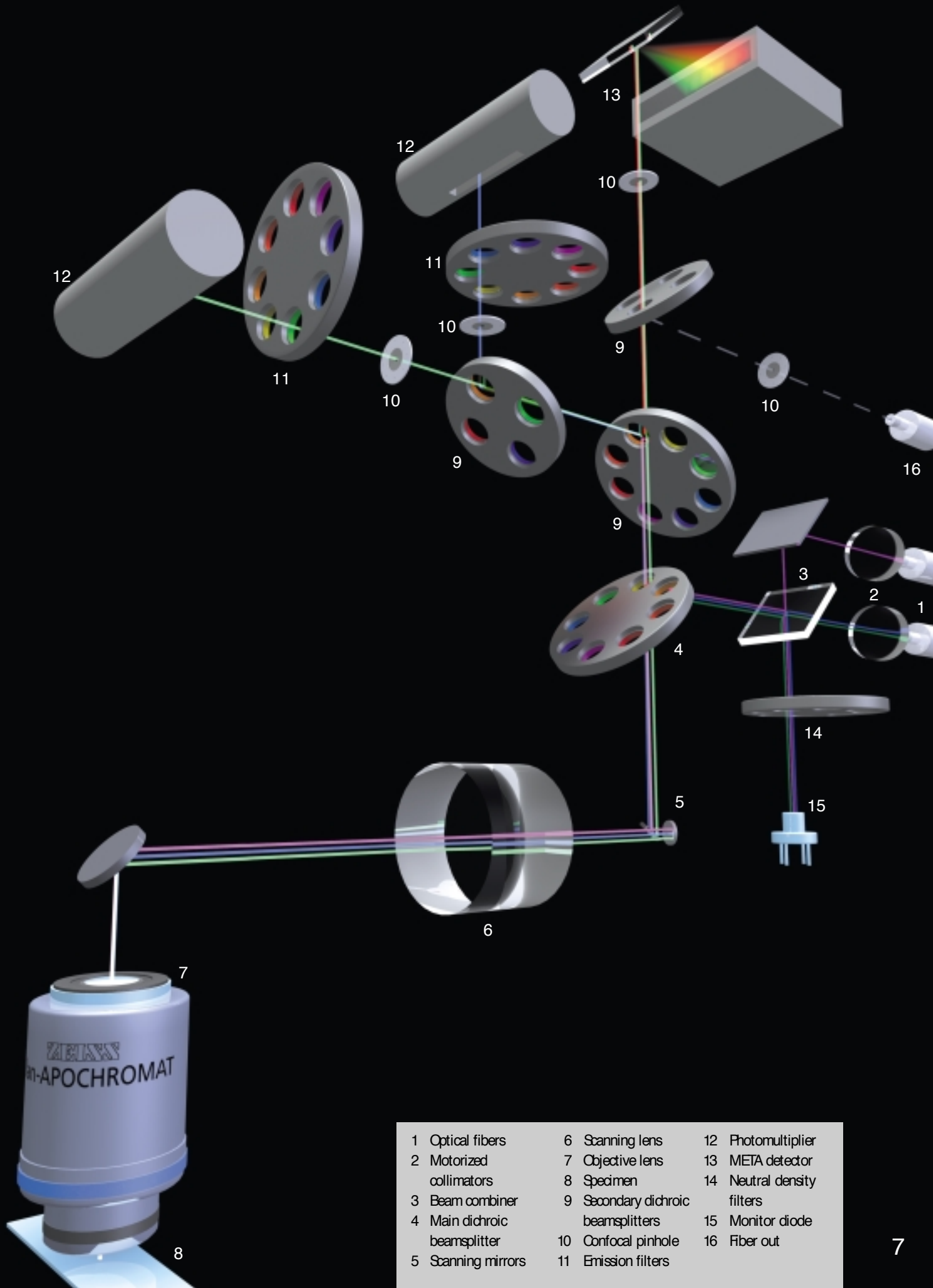

- | | | |
|------------------------------|------------------------------------|----------------------------|
| 1 Optical fibers | 6 Scanning lens | 12 Photomultiplier |
| 2 Motorized collimators | 7 Objective lens | 13 META detector |
| 3 Beam combiner | 8 Specimen | 14 Neutral density filters |
| 4 Main dichroic beamsplitter | 9 Secondary dichroic beamsplitters | 15 Monitor diode |
| 5 Scanning mirrors | 10 Confocal pinhole | 16 Fiber out |
| | 11 Emission filters | |

Emission Fingerprinting: Clear Color Separation in Multifluorescence

Lambda Stack

So far, the quality and information content in laser scanning microscopy has been determined by the spectral properties of the dyes used. As soon as several dyes with overlapping fluorescence emission spectra were used, a clear separation was possible only to a limited extent. The innovative LSM 510 META overcomes these restrictions in a sophisticated, yet easy way: through Emission Fingerprinting.

Emission Fingerprinting enables you to precisely separate the emission spectra of different dyes and lets you see things in an entirely new way. This technique for the recording, analysis and separation of emission signals (patent pending) generates an unmistakable and separate “emission fingerprint” of each dye used. Many scientific analyses which could not be performed so far can now be implemented.

The separation of the emission signals is performed as follows:

- Acquisition of a Lambda Stack
- Determination or selection of reference spectra
- Separation of mixed color spectra.

Acquisition of a Lambda Stack

The Lambda Stack, an image stack containing information on the dimensions x, y, z, t and λ , records the spectral signature of your specimen. The simultaneous, and therefore fast recording of spectrally resolved images guarantees optimum protection of your delicate specimens. Furthermore, Lambda Stacks allow you to capture even fast dynamic processes reliably and with a high information content.

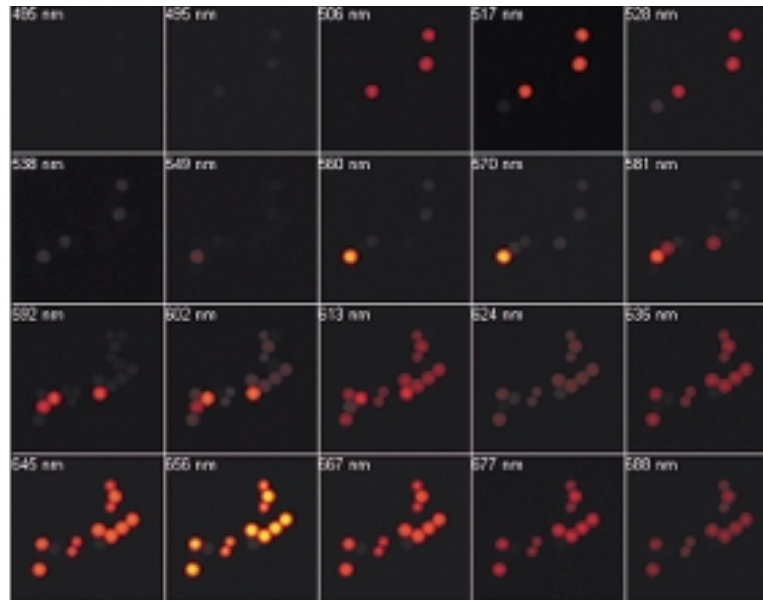

Four-population mix of single-labeled polystyrene beads:
Lambda Stack with spectral distribution of fluorescence emissions

“The solution that Zeiss has developed is very much targeted towards the problem we have – which is being able to follow multiple dyes within the preparation at the same time. I should say I’m very impressed with the data I have seen.”



Prof. Scott E. Fraser,
Biological Imaging Center, Caltech, Pasadena, USA

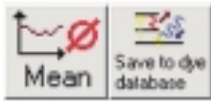

Determination or selection of reference spectra

Depending on your requirements, you determine the reference spectra of the various dyes used either automatically or interactively, using the Mean-of-ROI function. You can store these reference spectra in the spectra database of the LSM 510 META and recall them for further experiments.



Separation of mixed color spectra

The Linear Unmixing function separates the mixed signals pixel by pixel, using the entire emission spectrum of each dye in the examined specimen. As a result, even widely overlapping emission spectra, e.g. those of GFP and FITC, are separated precisely. Broadband autofluorescence can be eliminated reliably.

Four populations of single-labeled polystyrene beads:
Lambda-Coded representation with Regions Of Interest (ROI)

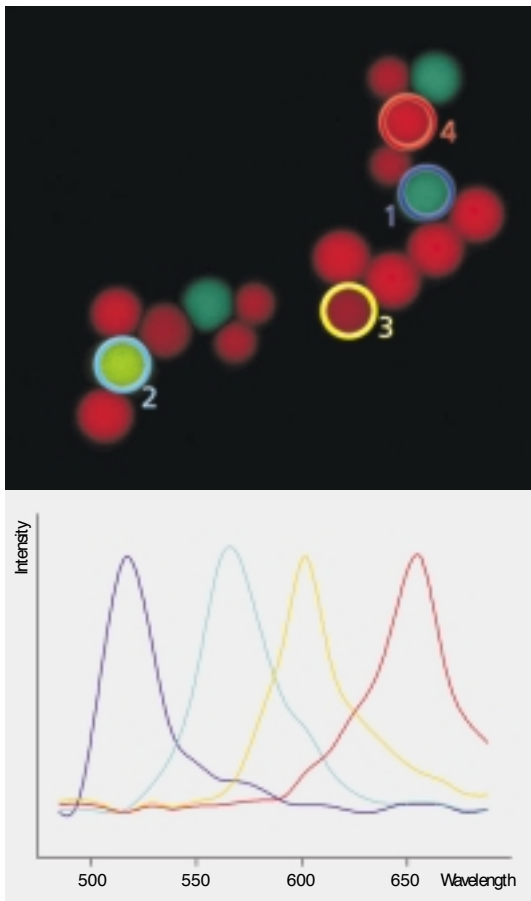

Spectral signatures of the fluorescence emission in the Regions Of Interest shown above: each dye can be clearly determined

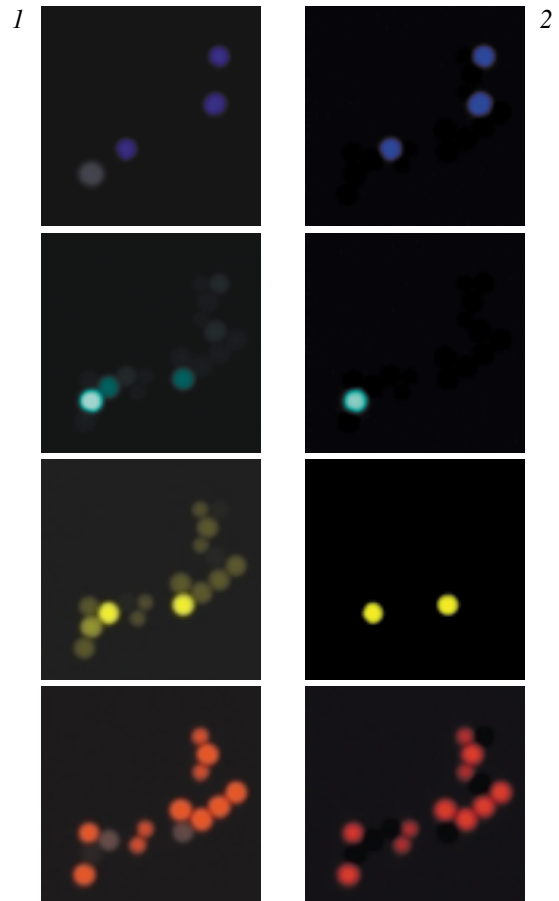

(1) Separation of emissions with bandpass filters: unsatisfactorily differentiated images
(2) Separation by Linear Unmixing: clear delimitation



Online Fingerprinting : Efficiency Meets High Speed

Our close cooperation with scientists in universities and research institutes has enabled us to consistently continue developing the Emission Fingerprinting technique.

Online Fingerprinting

In the Online Fingerprinting dialogue, reference spectra are selected prior to scanning. The spectrum is unmixed during the scanning procedure, and the result is displayed immediately. You no longer have to wait for the end of the scanning procedure to assess dynamic processes in living cells. Thus, the appropriate time to induce a reaction or apply a stimulus is easy to determine. You don't need to focus on the technique of your application, but can devote all your attention to the analysis of your work.

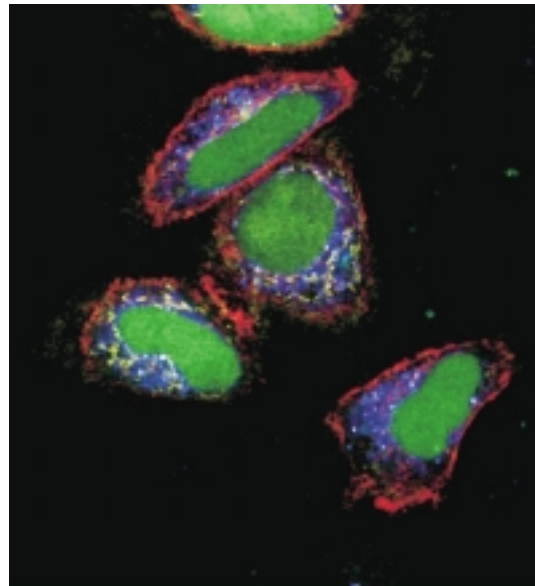

CFP, CGFP, GFP and YFP in cultivated cells after Emission Fingerprinting (Specimen: Dr. A. Miyawaki, RIKEN, Japan)

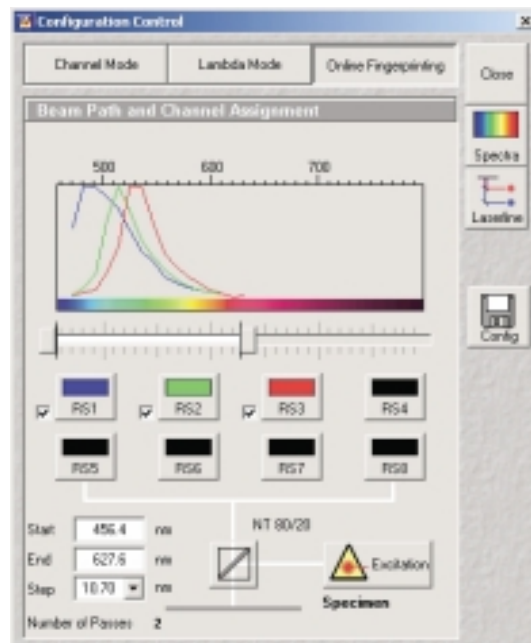

Online Fingerprinting. All the required settings from excitation to emission are made in a single menu.

"The new scan modes of the system offer a completely new quality of analysis. The interpretation of the data is far more reliable than with any conventional system based on filter sets and bandpass acquisition."



Dr. Frank-D. Böhmer,
Research Unit Molecular Cell Biology, Friedrich Schiller University of Jena, Germany

Dynamic Spectral Analysis: Time and Color Separation

Almost every specimen conceals information which the scientist can only obtain and use by specifically searching for it through special analysis functions.



Dynamic processes in the emission spectrum can only be “visualized” if the microscope system can appropriately analyze the time dimension. The LSM 510 META meets this requirement by creating Lambda-t data series.



Concealed emission spectra in the specimen are of major importance for research results. To be able to detect them, the LSM 510 META features a special analysis function: Automatic Component Extraction (ACE). This statistical technique extracts the dye spectra contained in the Lambda Stack, complementing the interactive detection of reference spectra.

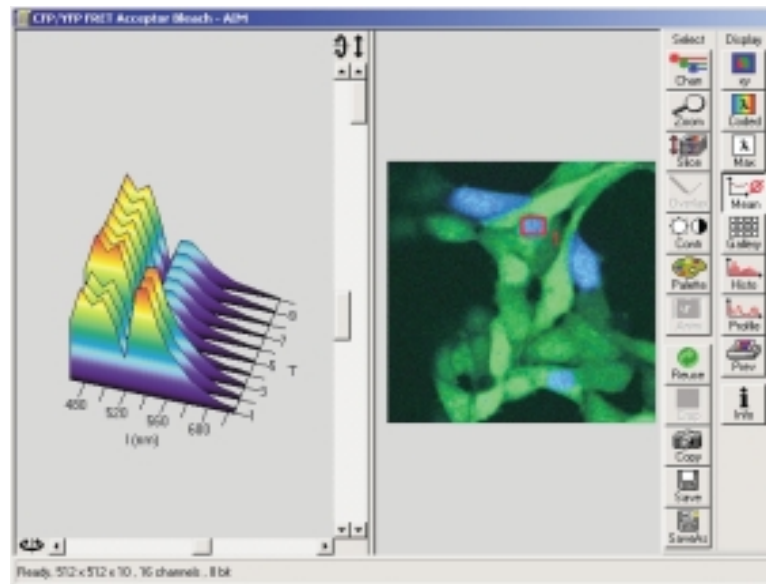

Lambda-t data series visualize dynamic processes.

The quality and “intelligence” of the analysis functions determine the results of the microscopic examinations to a large extent. The LSM 510 META detects concealed emission spectra via the Automatic Component Extraction (ACE) function.

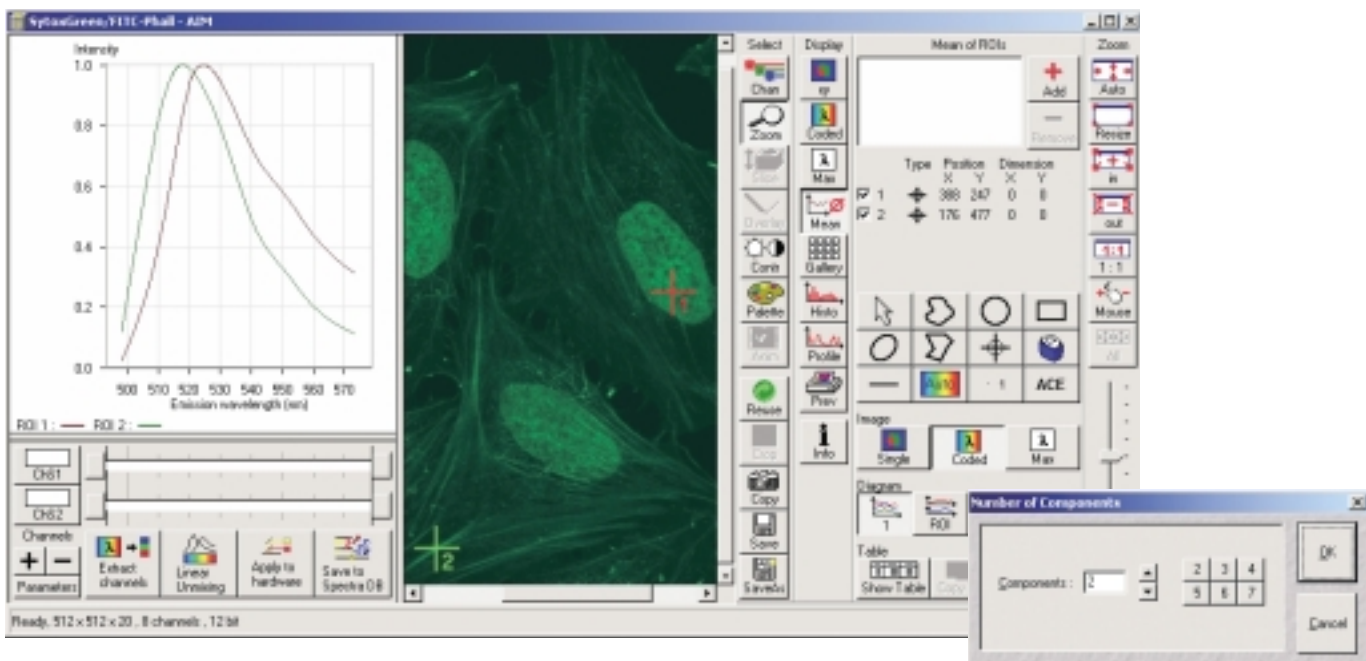

The Software: User-friendly Operation

1

Switch on the Laser
with Laser Control

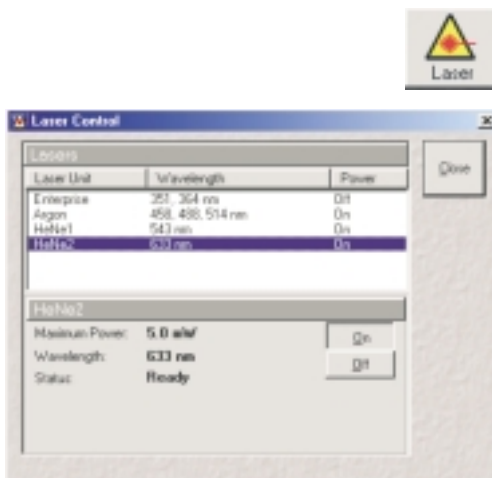

2

Set the Specimen
with Microscope Control

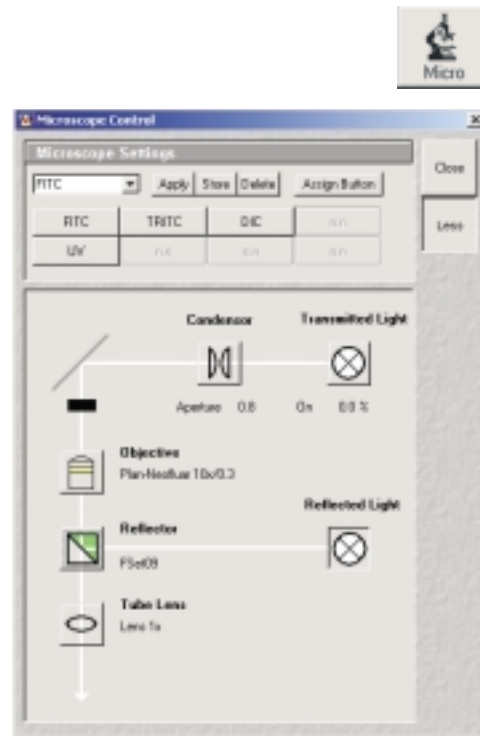

In the development of the LSM 510 META software, great attention has been paid to high operating convenience and mastering the combination of ease of use with high functionality.

The effort has been a success. This is confirmed by our customers, whose suggestions have contributed materially to design improvements.

Since the system is entirely motorized and coded, all system configuration parameters can be stored and recalled with a single mouse click. This *ReUse* approach guarantees high reproducibility of your results.

At the push of a button, the *Find* function will search for the ideal detector settings and automatically control each detector. This and many other functions support you in your work so that you can concentrate on what is really important.



1 2 3 4

3

Set Detection
with Configuration
Control or ReUse

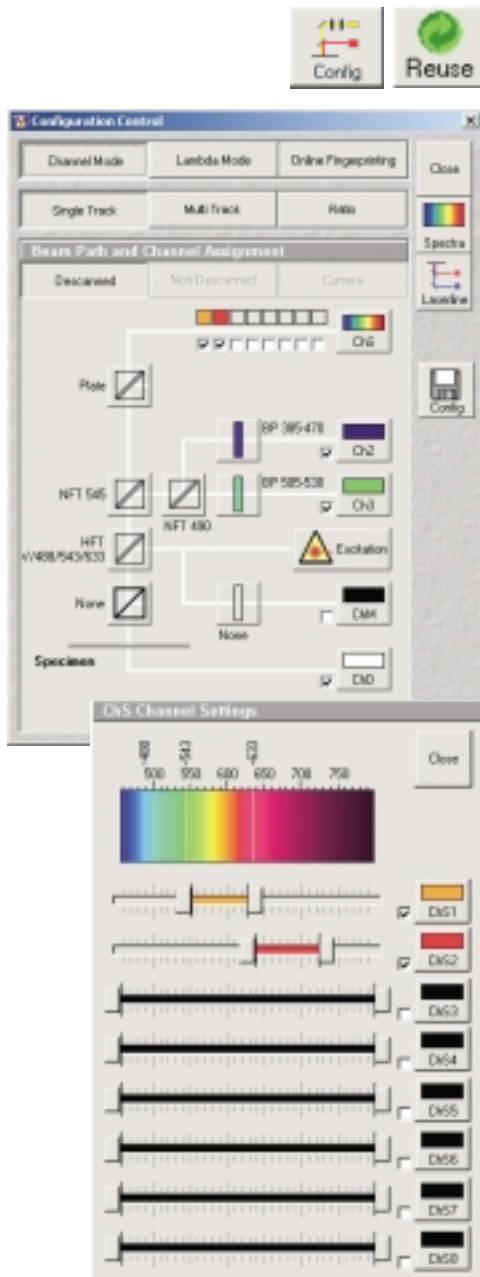

4

Scan
with Scan Control
or Find

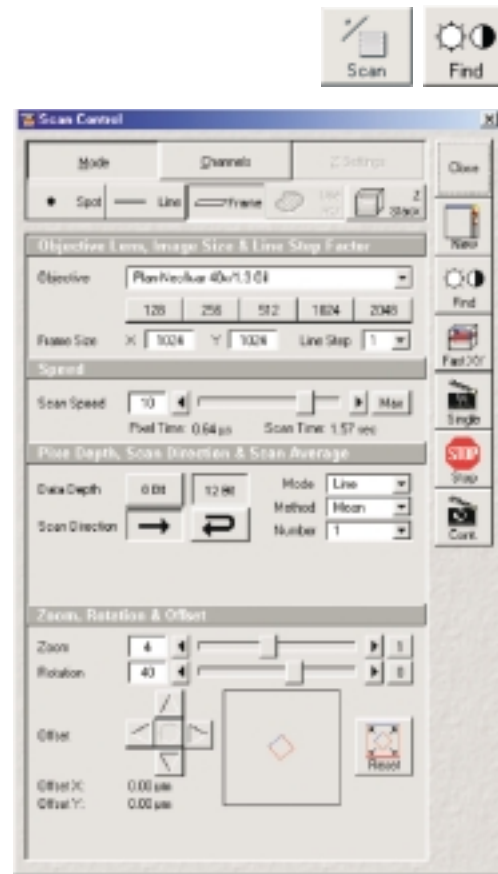





FRET and FRAP : Tracking down Biological Functions

Conventional imaging techniques depend on acquiring closely limited emission bands in order to minimize crosstalk. This applies, for example, to the examination of protein-protein interactions using the FRET technique, and to experiments with ion-sensitive dyes such as Indo-1 or SNARE. Compared to such conventional methods, the Emission Fingerprinting technique of the LSM 510 META offers substantial advantages because the entire signal is used.

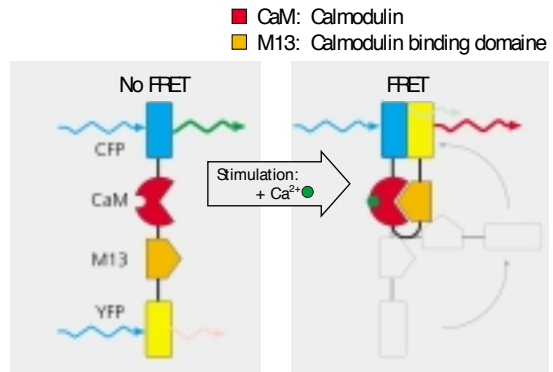

Calcium imaging using the FRET indicator Yellow Cameleon 2.

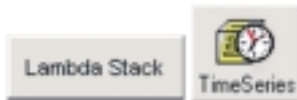

First, you can follow spectral signatures of the fluorescence and their changes in your specimen by means of acquiring a series of Lambda Stacks.



After acquisition of the Lambda Stacks, separate the emission signals and gain direct information about the FRET partners or of the binding statuses of the ion sensors.

After separation by Emission Fingerprinting:
The image shows a clear separation of the YFP and CFP fluorescence of Yellow Cameleon 2.
The Region Of Interest (ROI) is marked with a white square.

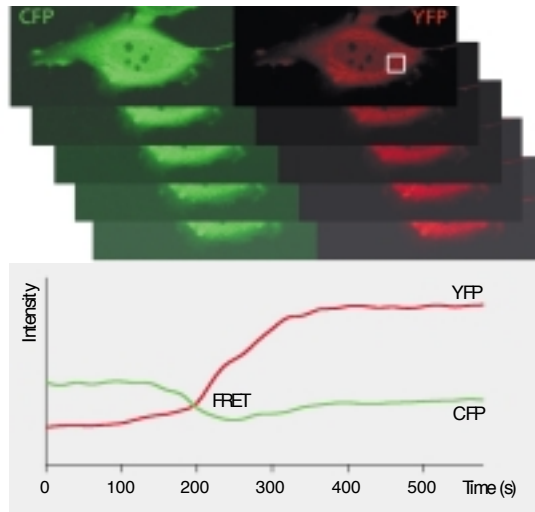

Intensities of the YFP and CFP signals within the ROI shown above.

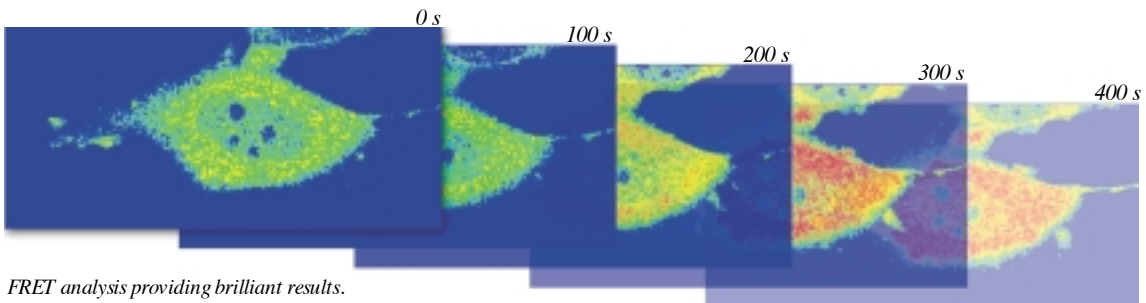

FRET analysis providing brilliant results.
The ratio between YFP and CFP fluorescence of Yellow Cameleon 2 was analyzed.
The calcium concentration markedly increases in the course of time.
(Dr. A. Miyawaki, RIKEN, Wako, Japan; Prof. Y. Hiraoka, KARC, Kobe, Japan)



"This system provides a very easy way to do FRAP experiments. I regret not having used this system earlier."



With the bleach function the acceptor can be switched off for checking FRET events. The precise interaction of AOTF and DSP in the LSM 510 META guarantees the pixel-precise control of the laser intensity, which is also the major requirement for FRAP and Uncaging experiments.

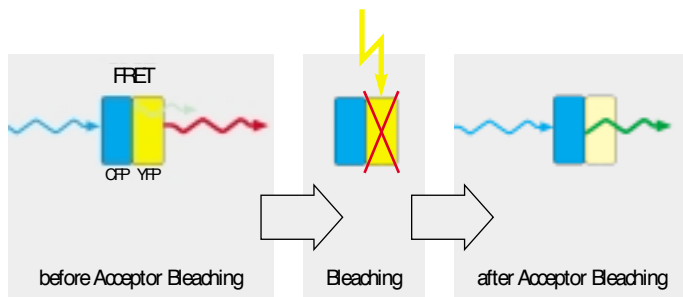

FRET between CFP and YFP in cultivated cells, detected by pixel-precise bleaching of the acceptor (YFP) and an increased donor signal (CFP)

before Acceptor Bleaching

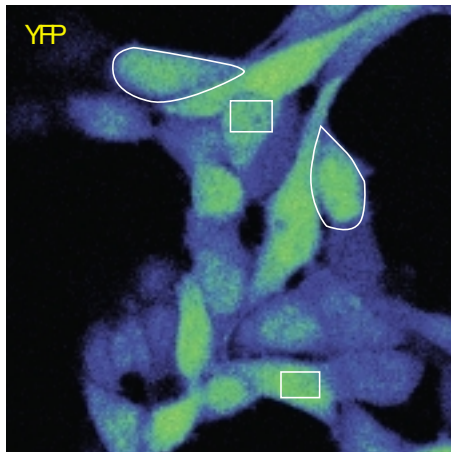

after Acceptor Bleaching

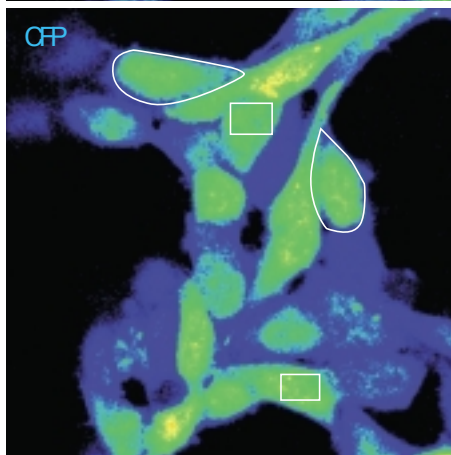
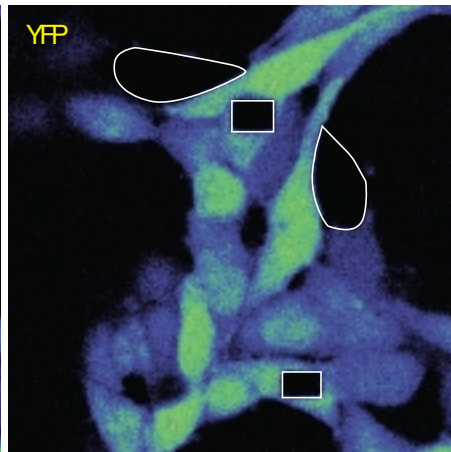

before Acceptor Bleaching

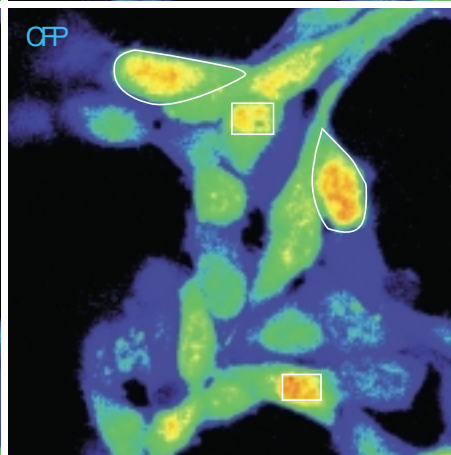

after Acceptor Bleaching



"The new META unit makes FRET imaging really easy because you get a spectral readout of both proteins."

Physiology Software : Complete Recording and Analysis Tool

In physiological examinations, the superb advantages of the LSM 510 META are particularly obvious. This is mainly due to the extremely fast and efficient scanning modes of the system. Plus, online ratio calculations permit direct data display even while the recording is still running. To make this possible, the system uses preset analysis formulas with user-defined parameter settings. Various modes are available for the calibration of dyes for concentration analyses. This technological configuration makes the LSM 510 META suitable for every dye and its specific fluorescence properties.

Display and Analysis of Ion Concentrations :



- Online and offline ratio for ratiometric dyes
- Online and offline F/F_0 for single-wavelength dyes
- Calibration for single-wavelength and ratiometric dyes
 - in situ and in vitro
 - including background correction
 - after titration with various curve fittings
 - according to Grynkiewicz
- Interactive scaling of image data series
- Interactive graphic display of the measured data from ROIs

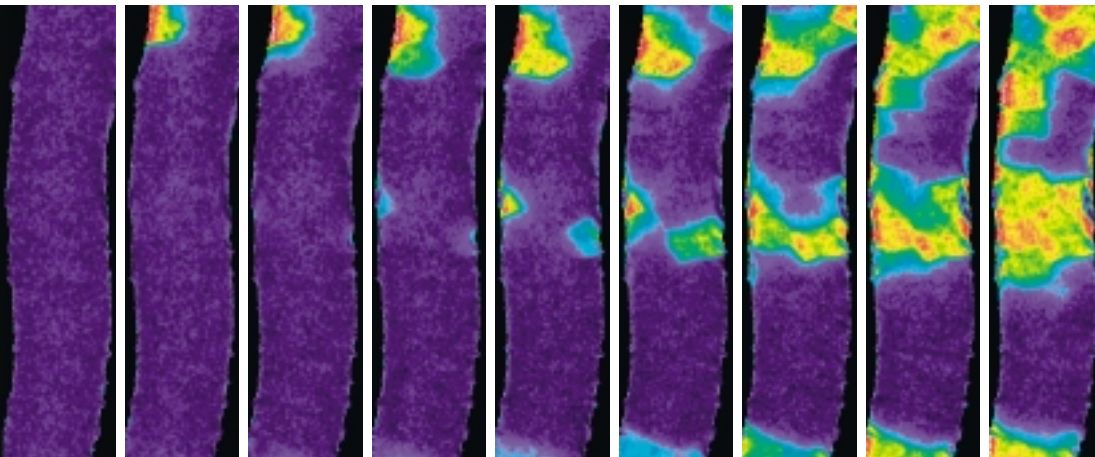

*Hormone-induced calcium changes in the salivary gland of an insect, visualized with Fluo-4.
(Dr. B. Zimmermann, Dr. B. Walz, University of Potsdam, Germany)*

Software dialog for the interactive calibration of ion-sensitive dyes

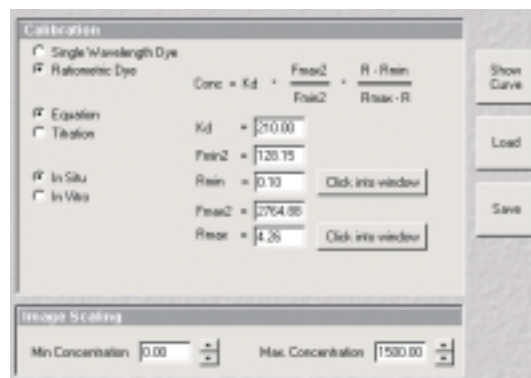

Quantitative Colocalization : Finding the Needle in the Haystack

The LSM 510 META enables you to easily perform quantitative colocalization analyses with a reliability and precision never achieved before. Image display, scattergram and data table are interactively linked to the ROI and thresholding tools. To give you an example: you select an area in the scattergram, and the existence of colocalization will be shown immediately in the unmixed image. Data table, histogram and image are interlinked in the same way. Data analysis can hardly be any more intuitive and precise.

Display and Analysis of Colocalization Experiments :

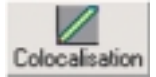

- Interactively linked image display, scattergram and data table
- Interactive or automated determination of thresholds
- Overlay of image channels with results of the colocalization analysis
- Quantitative colocalization analysis for up to 99 ROIs with:
 - area and average gray level intensity
 - colocalization degree
 - colocalization coefficient
 - Pearsons' correlation coefficient
 - Overlap coefficient according to Manders
- Export of analysis results

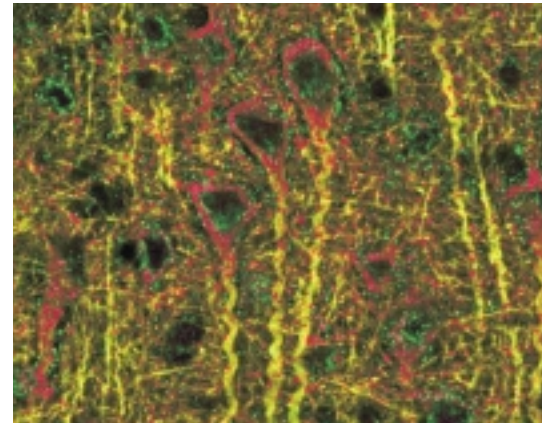
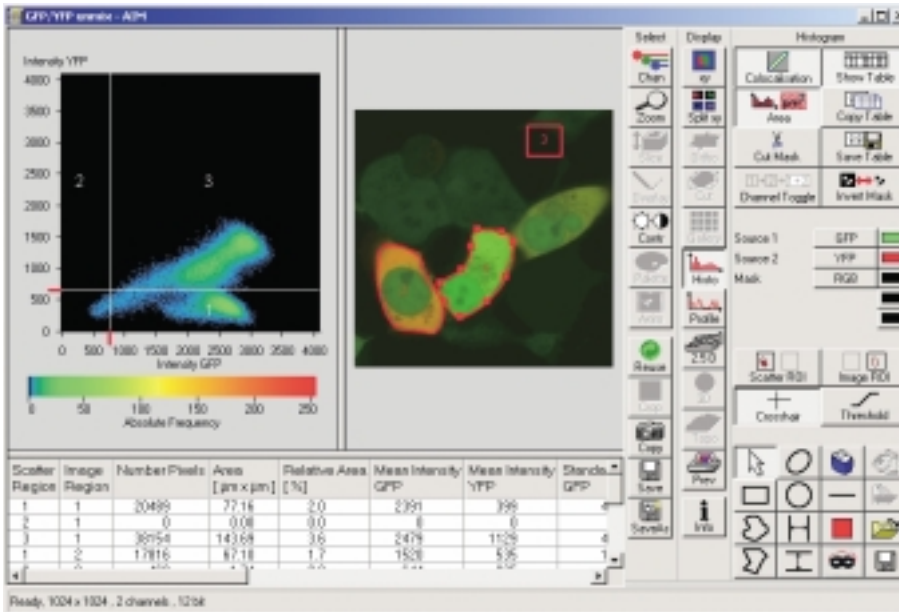

Qualitative (color-coded) colocalization analysis is often misleading – only quantitative tools (left) make things clear: cerebral cortex of the rat, double-stained mitochondria (Mn-SOD) marked green and red, and microtubuli (MAP2) marked yellow.
(Dr. J. Lindenau, University of Medical Neurobiology, University of Magdeburg, Germany)

Use first-class tools correctly:
image display, scattergram, and data table are interactively linked to the ROI and thresholding tools

“My people were thrilled.
We have been working on this for a year and now we have conclusive evidence that the proteins really interact.”



Selection of Tools : Research Made Easy

Multitracking - Metatracking



The fast, line-by-line change between excitation laser lines, known as Multitracking, is an appreciated procedure for the separation of overlapping fluorescence spectra. Of course, you can also perform this technique with the LSM 510 META. Using the new Metatracking technique, you can now optimize the bandwidth of your detection channels according to the emission characteristics of each dye and switch between different, yet overlapping bandpass characteristics line by line. This ensures optimum signal detection without any disturbing crosstalk in the case of critical dye combinations.

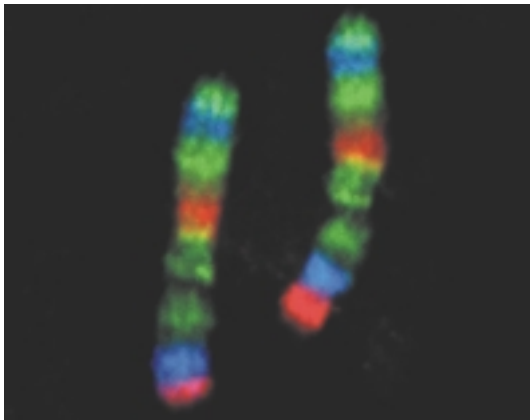

Multifluorescence in-situ hybridization (MFISH) of human metaphase chromosomes (Dr. T. Liehr and Dr. V. Beensen, University of Jena, Germany)

Of course, all the image recording, image analysis and image display functions of the LSM 510 have been integrated in the LSM 510 META, and have even been systematically improved and extended.

Linear Unmixing



The Linear Unmixing function separates the mixed signals pixel by pixel by using the entire emission spectrum of each fluorescence marker in the specimen. As a result, even greatly overlapping emission spectra, e.g. those of GFP and FITC, are separated reliably, and broadband autofluorescence is eliminated. This provides solutions to problems unsolvable so far and enables completely new experimental approaches.

ECFP-RanGAP (blue), GFP-emerin (green) and YFP-SUMO1 (red) expression in cultured cells (Prof. Y. Hiraoka, KARC, Kobe, Japan)

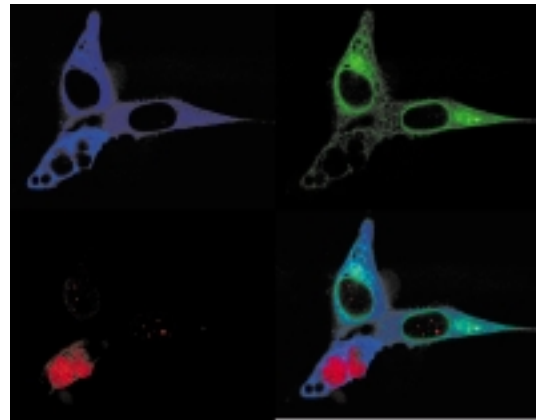

CFP (blue), GFP (green) and YFP (red) expression in the nuclei of NIH3T3 cells (Dr. M. Dickinson, Dr. R. Lansford, Prof. S. Fraser, Caltech, Pasadena, USA)

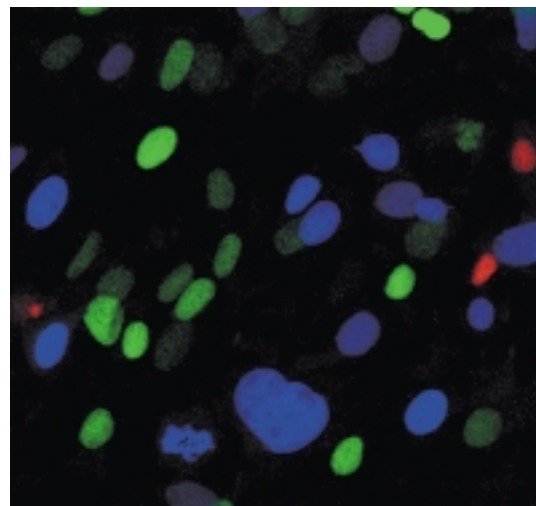



"The power of the Zeiss system is not only in its sensitivity, its software and its user-friendliness, but also in the technical enhancements for spectral selection."

3 D Visualization



The extensive 3D visualization modes of the LSM 5 Image VisArt software package provide new, undreamed-of insights into the spatial structures of your specimen. Fast 3D and 4D reconstruction and various projection and animation options afford an entirely new understanding of interrelations for research and training.

For higher resolution demands, deconvolution functions have been implemented on the basis of calculated Point Spread Functions (Nearest Neighbor, Maximum Likelihood, Constraint Iterative).

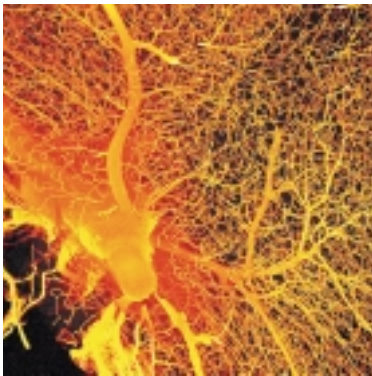

Capillary network of a rat after injection of rhodamine

Zebrafish embryo, eye and part of the brain ; cell adhesion molecule Tag-1 (Alexa Fluor 488, green), tubulin (Cy3, red), sugar epitope PSA (Cy5, purple), cell nuclei (DAPI, blue). (Dr. M. Marx and Prof. M. Bastmeyer, Constance University, Germany)

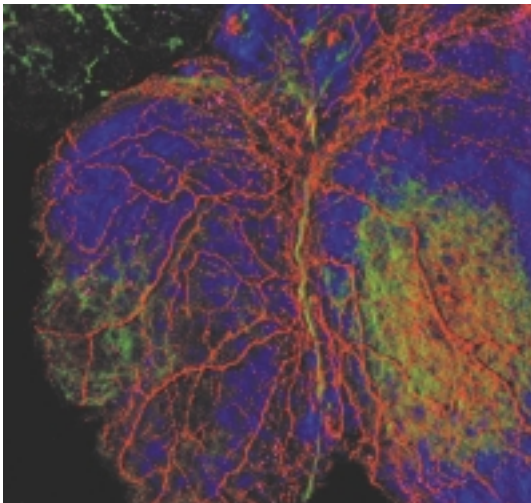

Multifluorescence



To optimize multifluorescence analyses, the LSM 510 META provides the unique possibility of combining the META detector with other single detectors. This enables you to configure the spectral range of the META detector as required, and to achieve maximum signal yield via the single detector at the same time. In fact, individually adjustable and positionable pinholes of **each** detector offer you an easy way to make your experiments perfect.

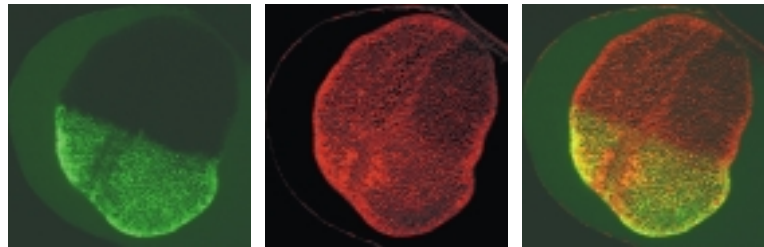

GPI-GFP (green) and FM4-64 (red) fluorescence in wing buds of the fruit fly *Drosophila melanogaster* (V. Greco and Dr. S. Eaton, Max Planck Institute of Cell Biology and Genetics, Dresden, Germany)

Actin (Alexa 488-phalloidin, green) and paxillin (Texas Red, red in cultured fibroblasts) (Dr. M. A. Woodrow, University of California, San Francisco, USA)

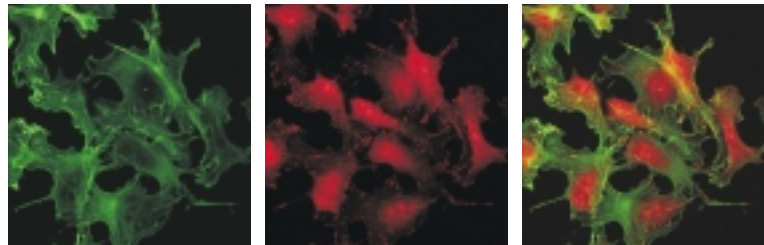

Specification

LSM 510 META System Components

Microscopes

Models	Upright: Axioplan 2 imaging MOT, Axioskop 2 FSMOT; Inverted: Axiovert 200 M BP (Base Port) or SP (Side Port)
Z drive	DC motor with optoelectronic coding, smallest increment 25 or 50 nm; fast piezo objective focus attachment
HFZ 200 (option)	High-precision galvanometric fine focusing stage, total lift 200 μm , smallest increment 10 nm
XY stage (option)	Motorized XY scanning stage, with Mark & Find (xyz) and Tile Scan (mosaic scan) functions, smallest increment 1 μm
Accessories	Digital microscope camera AxioCam, integration of incubation chambers, micromanipulators, etc.

Scanning module

Models	META scanning module with two single-channel detectors and a polychromatic multichannel detector (each genuinely confocal with selected, high-sensitivity FMTs) prepared for lasers from UV to NIR
Scanner	Two independent galvanometric scanning mirrors, DSP-controlled, providing ultrashort line and frame flyback times
Scanning resolution	4x1 to 2048x2048 pixels, also for several channels, continuous adjustment
Scanning speed	13x2 speed stages; up to 5 frames/s with 512x512 pixels (max. 77 frames/s with 512x32 pixels); min. 0.38 ms for a line of 512 pixels
Scanning zoom	0.7x to 40x, digital, variable in steps of 0.1
Scanning rotation	Free 360° rotation, variable in steps of 1 degree, free xy offset
Scanning field	18 mm diagonal field (max.) in the intermediate image plane, homogeneous illumination
Pinholes	Pinholes for each epi-illumination channel (single-channel detector or META multichannel detector), individual adjustments of size and position, preadjusted
Detection	Standard: three confocal epi-illumination channels simultaneously (META detector + 2 single-channel detectors), each with a high-sensitivity FMT detector. Options: transmitted-light channel with FMT; monitor diode for measuring the excitation intensity. New: Simultaneous acquisition of up to 8 channels; META: fast acquisition of Lambda Stacks, also in combination with time series
META detector	Polychromatic 32-channel detector for fast acquisition of Lambda Stacks and Metatracking
Data depth	Selectable between 8 bit and 12 bit, individual 12-bit A/D converter for each of 8 channels

Laser modules

VIS laser module	Polarization-preserving single-mode fiber, temperature-stabilized VIS-AOTF for simultaneous intensity control of up to 6 visible-light laser lines, switching time < 5 μs ; AOTF reprogramming via the LSM software; Diode laser (405 nm) 25 mW; Ar laser (458, 477, 488, 514 nm) 30 mW; ArKr laser (488, 568 nm) 30 mW; HeNe laser (543 nm) 1 mW; HeNe laser (633 nm) 5 mW (end-of-lifetime specification)
UV laser module	Polarization-preserving single-mode fiber, temperature-stabilized UV-AOTF for simultaneous intensity control of two ultraviolet laser lines, switching time < 5 μs ; Ar laser (351, 364 nm) 80 mW; optional Kr laser (413 nm) 40 mW (end-of-lifetime specification)
Multiphoton option	Direct or fiber coupling of pulsed NIR lasers into the scanning module; various makes are supported. Grating Dispersion Compensator (GDC) and Post Fiber Compressor (FFC) for optimum pulse shaping. Fast change of laser intensity by means of ACM. Up to 4 external detectors for Non-Descanned Detection (NDD). Objectives optimized for use in the NIR range

Electronics module

LSM 510 Control	Control of the microscope, the VIS and UV laser modules, the scanning module and further accessories. Monitoring of data acquisition and synchronization by a Digital Signal Processor (DSP). Data exchange between DSP and computer via ultra-wide SCSI
Computer	High-end PC with ample RAM and hard disk storage capacity, ergonomic high-resolution monitor or TFT flat-panel display, many accessories; Windows 2000/NT 4.0 operating system with multi-user capability



Standard Software

System configuration	Convenient control and configuration of all motorized microscope functions, of the laser and scanning modules Saving and restoration of application-specific configurations
ReUse function	Restoration of acquisition parameters per mouse click
Acquisition modes	Spot, Line/Spline, Frame, Z Stack, Lambda Stack, Time Series and combinations: xy, xyz, xyt, xyzt, xz, xt, xzt, Spot-t, xλ, xyλ, xyzλ, xytλ, xyzλ, xzλ, xtλ, xztλ, On-line computation and presentation of ratio images Averaging and summation (linewise or framewise, configurable). Step Scan (for higher frame rates, configurable)
Auto-Z function	On-line adaptation of Z Stack acquisition parameters for uniform brightness distribution
Crop function	Convenient selection of scanning ranges (zoom, offset, rotation simultaneously)
RealROI scan	Scanning of up to 99 ROIs (regions of interest) of any shape, with pixel-accurate laser blanking
ROI bleach	Localized photobleaching of up to 99 bleaching ROIs for applications such as FRAP (Fluorescence Recovery After Photobleaching) or uncaging
Spline scan	Scanning along a freehand defined line
Multitracking	Acquisition of multiple fluorescences; fast change of excitation lines minimizes signal crosstalk
Metatracking	Extension of Multitracking by fast electronic change of detection channels, even with overlapping bandpasses, ensures optimum signal detection (only with META detection module)
Lambda Stack scan	Fast simultaneous acquisition of image stacks with spectral information for every pixel (only with META detection module)
Emission Fingerprinting	Technique for generating crosstalk-free multiple-fluorescence images with fast simultaneous excitation, unmixing possible online or offline, automatic or interactive
Presentation	Orthogonal view (xy, xz, yz in a single presentation), cut view (3D section made under a freely definable spatial angle), 2.5D view for time series of line scans, projections (stereo, maximum, transparent) for single frames and series (animations), depth coding (pseudo-color presentation of height information). Brightness and contrast adjustments; off-line interpolation for Z Stacks, selection and modification of color lookup tables (LUT), drawing functions for documentation
Analysis	Advanced tools for colocalization and histogram analysis with individual parameters and options profile measurement of straight lines and curves of any shape, measurement of lengths, angles, areas, intensities, etc.
Image operations	Addition, subtraction, multiplication, division, ratio, shift, filters (low-pass, median, high-pass, etc.; user-definable)
Data archiving, export, import	LSM image database with convenient functions for managing images together with their acquisition parameters; Multipart function for creating assembled image and data views; more than 20 file formats (TIFF, BMP, JPG, PSD, PCX, GIF, AVI, Quicktime ...) for compatibility with all common image processing programs

Software Options

LSM Image VisArt	Fast 3D and 4D reconstruction and animation (various modes: shadow projection, transparency projection, surface rendering)
3D Deconvolution	Image restoration based on computed point spread functions (modes: nearest neighbor, maximum likelihood, constraint iterative)
Multiple Time Series	Complex time series with change of application-specific configurations, autofocus and bleaching functions
3D for LSM	3D presentation and measurement of volume data records
Physiology	Extensive Software for the analysis of time series, graphical mean-of-ROI analysis, online and offline display and calibration of ion concentrations
Topography package	Visualization of 3D surfaces (fast rendering modes) plus many measurement functions (roughness, surface areas, volumes)
VBA Macro Editor	Acquisition and editing of routines for the automation of scanning and analysis functions

Image Browser Free Software Package for display, editing, archiving, print and export/import of LSM 5 images

System Overview LSM 510 META

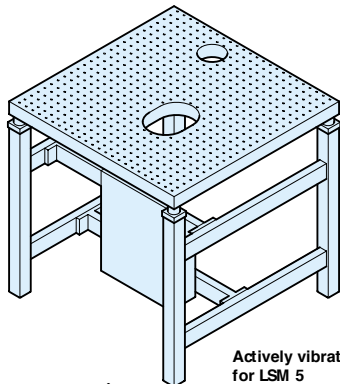
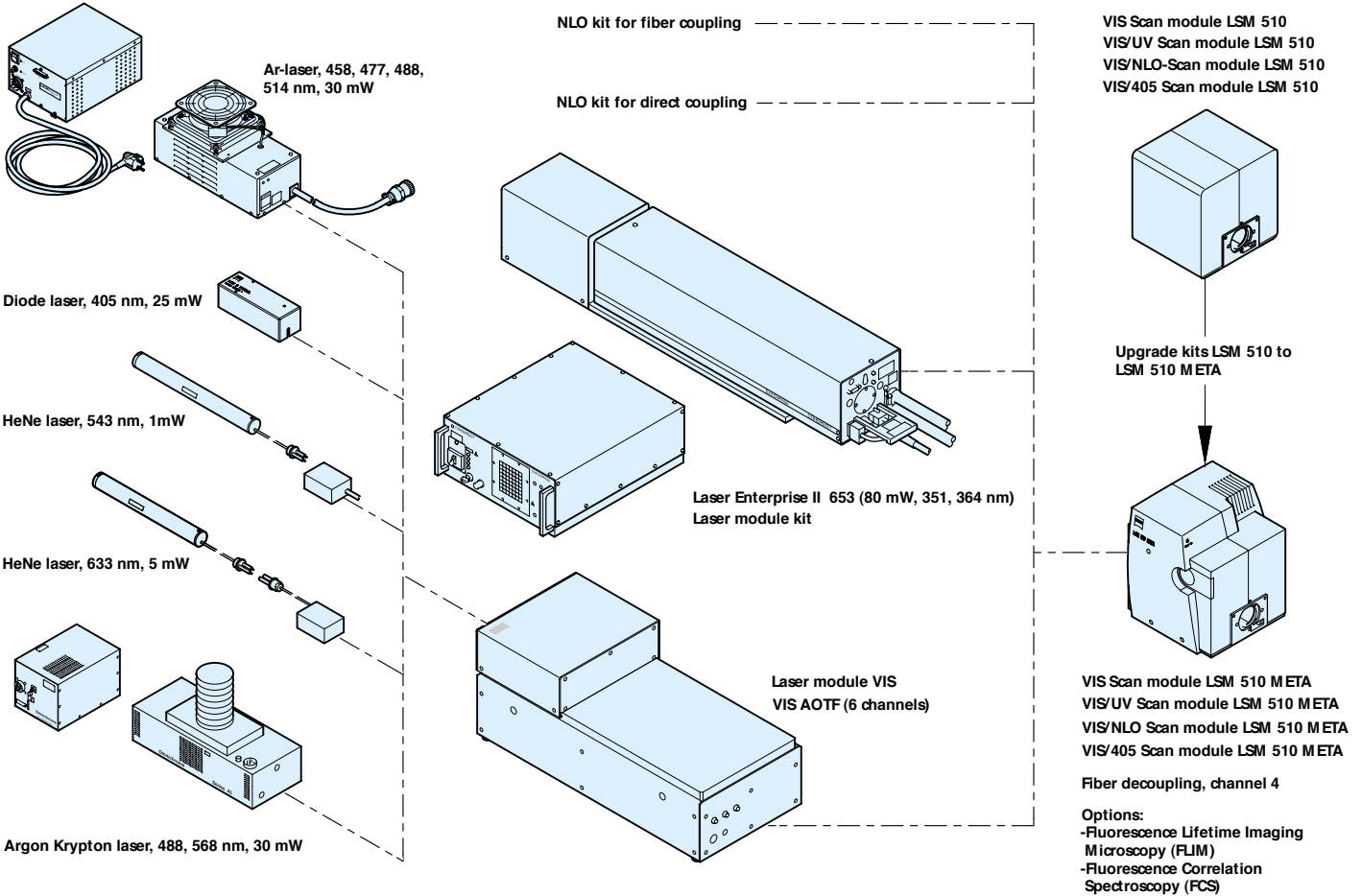

Actively vibration-absorbed system table for LSM 5
 Table surface 30" x 30"

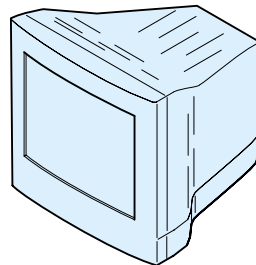

Monitor 21" (50 cm)

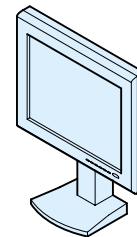

LCD TFT-Flatscreen 18"

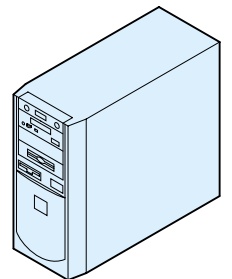

Host computer

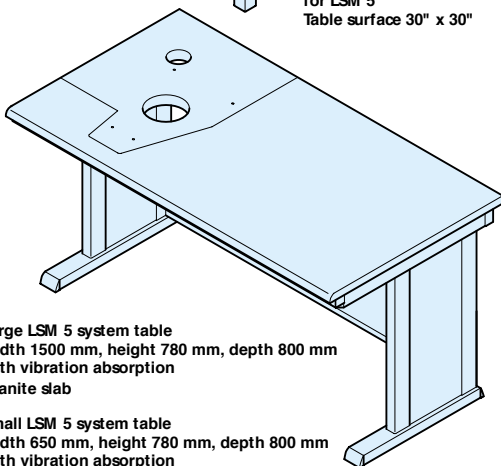

Large LSM 5 system table
 width 1500 mm, height 780 mm, depth 800 mm
 with vibration absorption
 Granite slab

Small LSM 5 system table
 width 650 mm, height 780 mm, depth 800 mm
 with vibration absorption
 Granite slab

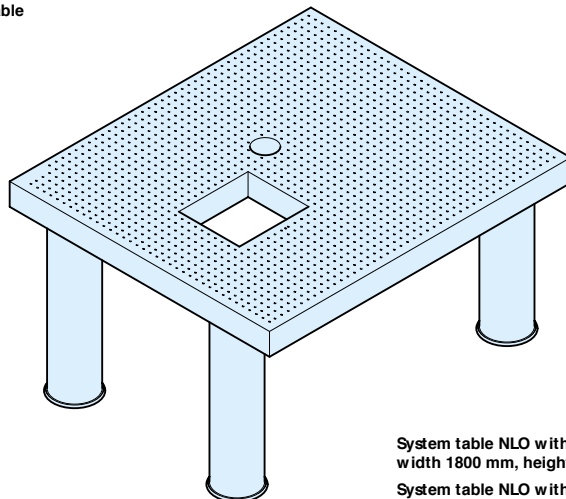

System table NLO with active absorption
 width 1800 mm, height 750 mm, depth 1400 mm
System table NLO with active absorption
 width 1200 mm, height 750 mm, depth 1400 mm

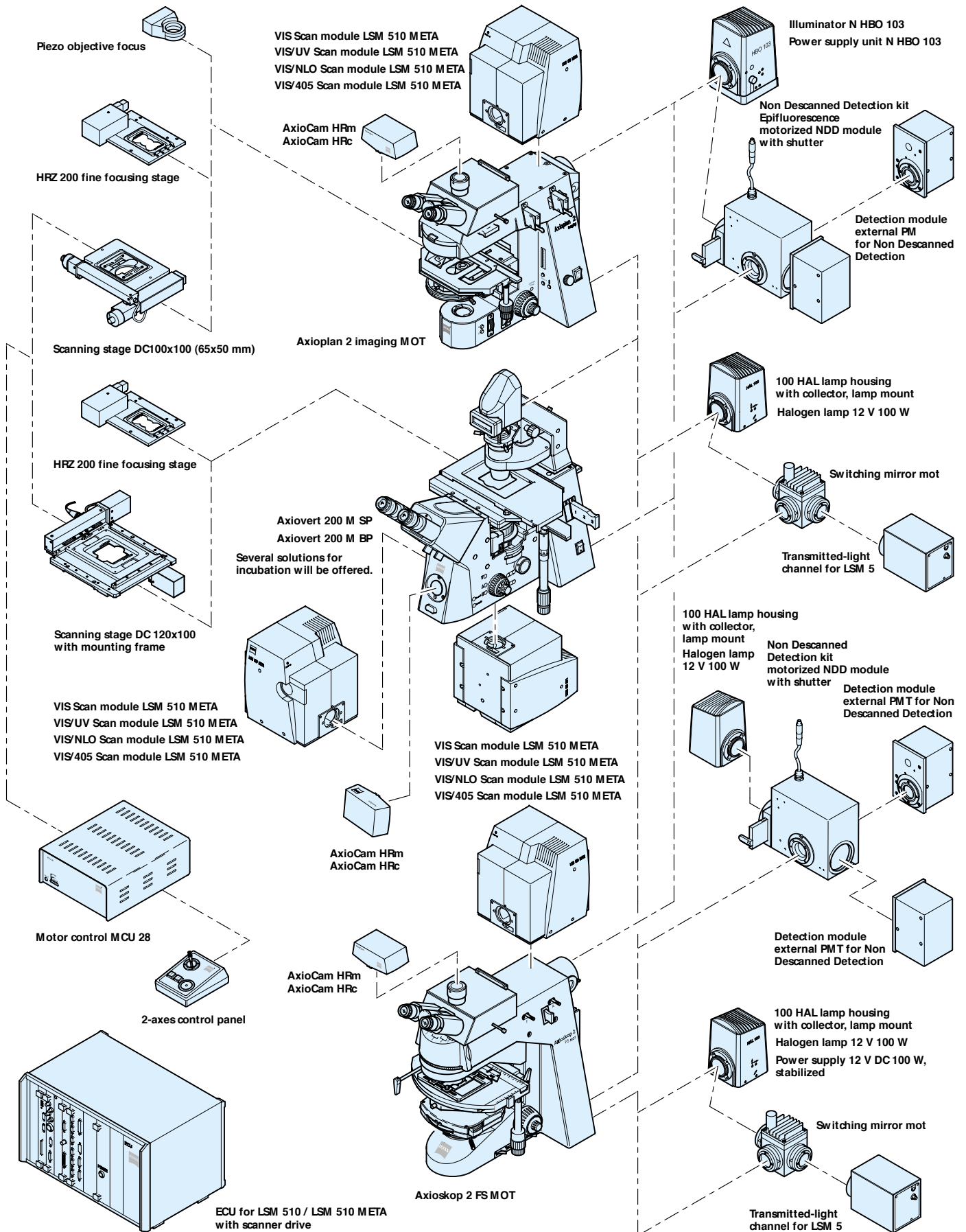

Our Services



Thanks to many years of experience in the development of laser scanning microscopes, we are able to offer you a system the components of which are perfectly matched to each other and which can be combined and extended. Here we profit from the application-oriented design of the fifth generation of laser scanning microscopes from Carl Zeiss.

The new detection module permits LSM 510 systems already installed to be easily upgraded into the LSM 510 META at the customer's site.

Existing optical, mechanical and electronic interfaces enable step-by-step upgrading for further techniques, for example the measurement of molecule interactions via FCS (Fluorescence Correlation Spectroscopy), multiphoton microscopy or FLIM (Fluorescence Lifetime Imaging).

New scanning and analysis techniques are made available quickly and easily via software upgrades.

Our experts are continuously developing new software and hardware modules to meet your challenging application requirements. Over the past two decades, your applications expertise, combined with our know-how in scientific instrument design, have helped us to transform the laser scanning microscope from a 3D imaging device into a very versatile and flexible imaging and analysis center.

This makes the LSM 510 META a rewarding long term investment.

Professional Support

The laser scanning system you purchase should be configured to suit the range of your applications. Especially in a multi-user environment, making the right decision is a complex task, with many different requirements to be matched.

Our LSM team specialists, familiar with the market and components from other manufacturers, will guide you in **selecting the right system**.

We are committed to supporting you in your efforts **with specific advice on applications and technology** for your examination methods.



Functions of Laser Scanning Microscopes from Carl Zeiss

Reliable Service

To ensure smooth operation of your LSM 510 META, we offer you the following services:

Our regional consultants and technicians provide reliable services and technical support to assist you in your research.

After every system installation, a **comprehensive introduction to LSM applications** is offered to the users.

Furthermore, Carl Zeiss offers **training courses and workshops**, which provide in-depth know-how about practical topics and applications in laser scanning microscopy.

Automatic Component Extraction

Statistical procedure for the detection of single dye spectra in a Lambda Stack.

Emission Fingerprinting (patent pending)

Method available with the LSM 510 META for the recording, analysis and separation of emission signals in multifuorescence images; also suitable for widely overlapping spectra.

Lambda Stack

Image stack with information in x, y and λ ; combinable with z and/or time series; for the determination of spectral signatures at any specimen location.

Linear Unmixing

Mathematical procedure for the spectral deconvolution of multiple emission signals.

Metatracking

Scanning mode available with the LSM 510 META, similar to Multitracking, but with additional fast switching between detection settings.

Multitracking

Scanning mode available with the LSM 5, generates multifuorescence images without crosstalk of emission signals, by means of fast switching between excitations, and quasi-simultaneous detection.

RealROI (rROI) Scan

Scanning mode in which freely definable specimen areas are excited and imaged; guarantees maximum specimen protection thanks to exact blanking of the laser lines outside the selected specimen areas.

ROI Bleaching

Defined photobleaching of several, freely defined specimen areas, e.g. for FRAP, Uncaging, or Photoactivation experiments.

Spline Scan

Scanning along a freehand-defined line for recording fast (physiological) processes, e.g. along neurons.

Spot Scan

Scanning mode in which the signal intensity at a confocal point can be tracked with extremely high temporal resolution.

Step Scan

Fast overview scan in which intermediate lines are added by interpolation.

Tile Scan

Records an overview image consisting of a number of tiled partial images for the recording of larger objects with improved resolution.



Glossary

ACE	Automatic Component Extraction
ADC	Analog-to-Digital Converter
AOM	Acousto Optical Modulator
AOTF	Acousto Optical Tunable Filter
CFP	Cyan Fluorescent Protein
DIC	Differential Interference Contrast (Nomarski)
DSP	Digital Signal Processor
FCS	Fluorescence Correlation Spectroscopy
FLIM	Fluorescence Lifetime Imaging Microscopy
FRAP	Fluorescence Recovery After Photobleaching
FRET	Fluorescence Resonance Energy Transfer
GFP	Green Fluorescent Protein
NLO	Non-Linear Optics (multiphoton imaging)
ROI	Region Of Interest
YFP	Yellow Fluorescent Protein



2002: The LSM 510 META wins the renowned R&D 100 award for technical developments.



For further information, please contact :

**Carl Zeiss
Advanced Imaging Microscopy**

07740 Jena
GERMANY

Phone: ++49-36 41 64 34 00

Telefax: ++49-36 41 64 31 44

E-Mail: micro@zeiss.de

www.zeiss.de/lsm

Subject to change.

Printed on environment-friendly paper,
bleached without the use of chlorine.